

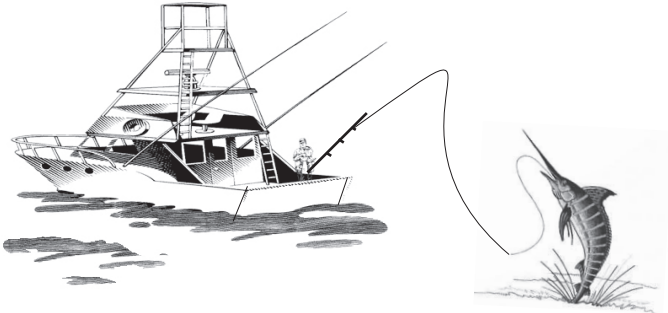

Quality Line-Plumbing Specialties

Orlando, Florida



*Servicing the Southeast
"Since 1965"*

E-mail: customerservice@tmsmarlin.com

Toll Free: 1-800-327-3022 Fax Free: 1-800-327-5689

Ceramic Stems, Thermostatic & Single Lever Cartridges 2024



Marlin Coral Collection Ceramic Faucets

High quality (**LEAD FREE**) Single lever and two-handle lavatory faucets, single lever and two-handle kitchen faucets, bar faucets, single lever pressure balance tub & shower valves. Featured here are our most popular faucets.

*Coral Collection
Faucet Series*

Two-Handle Lavatory Faucet



#40100439

High Rise Bar Faucet



#40100465

Two-Handle High Rise Faucet



#40100438

Single Lever Lavatory Faucet



#40100441

Single Lever Kitchen Faucet



#40100435

Two-Handle Wide Spread Faucet



#33045

Single Lever Pressure Balance Faucet



#40100243

Two-Handle Kitchen Faucet



#40100437

Marlin A Time Saving Stem Guide

GE50 Stem only hot & cold (Pair)

(COLD) Counter clockwise to close

GE50-H Hot stem only

(HOT) Clockwise to close

GE50-C Cold stem only

99% of tub & shower faucets use clockwise turn off (Hot) on both sides

GE50UH Hot stem with gland

Color coded stems

GE50U Hot & Cold stem units with gland (Pair)

(COLD) Blue

(HOT) Red



GE50D Diverter stem only

GE50DU Diverter stem unit with gland

Measure your Stem and Cartridge here!

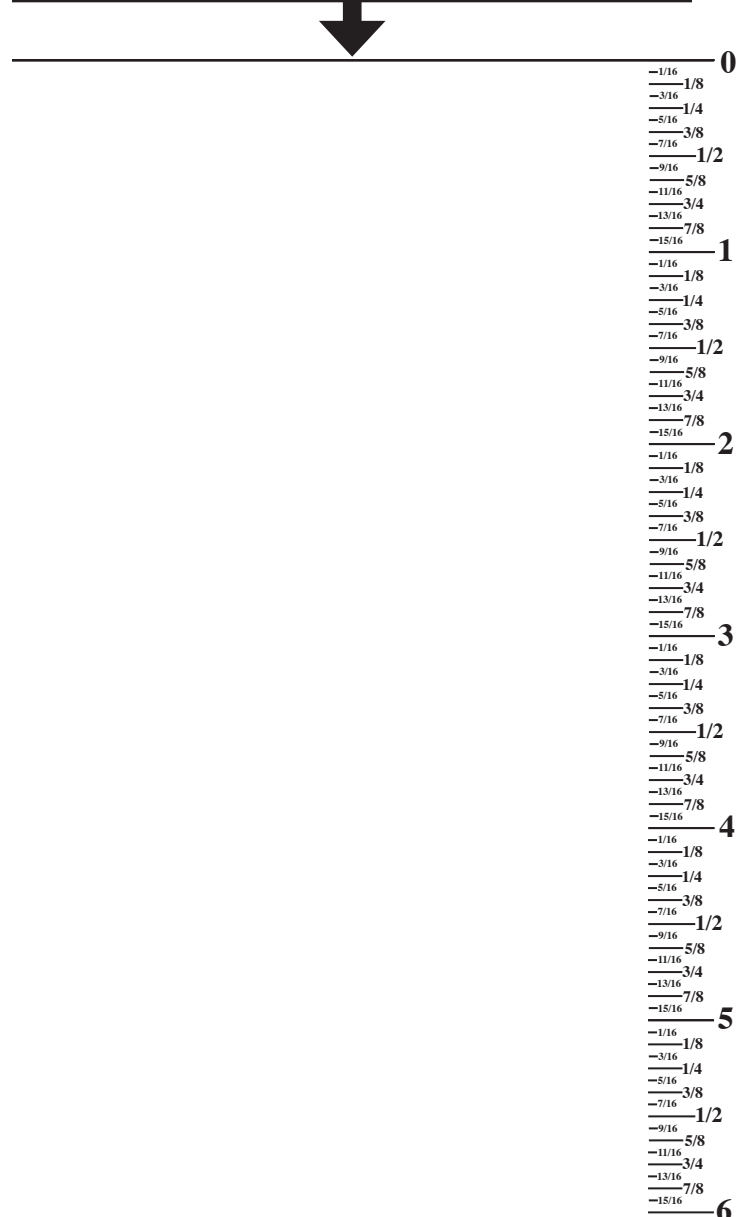

SINGLE LEVER CERAMIC CARTRIDGES (ALPHABETICAL ORDER BY MANUFACTURE)



CARTRIDGE	PAGE No.	CARTRIDGE BRAND	HEIGHT	WIDTH
AS34U	10	Am/Standard	2-3/16"	1-9/16"
AS35U	10	Am/Standard	2-3/16"	1-5/16"
AS36U	10	Am/Standard	2-3/16"	1-9/16"
AS40U	10	Am/Standard	2-1/4"	1-13/16"
AS46U	10	Am/Standard	2-1/4"	1-13/16"
AS60U	11	Am/Standard	2-1/8"	1-13/16"
AS61U	11	Am/Standard	2-7/16"	1-15/16"
AS90U	11	Am/Standard	2-3/16"	1-15/16"
2609	12	Am/Standard	1-7/8"	2-5/16"
40120439	12	Am/Standard	2-3/16"	1-13/16"
2811	12	Am/Standard	2"	2-5/16"
40120700	13	Am/Standard	2-7/16"	2-1/8"
21563	13	Am/Standard	2-5/16"	2-3/8"
40123061	13	Am/Standard	2-1/8"	2-9/16"
27780	14	Behavior Safety	4"	1-1/2"
CF35U	14	Chicago Faucet	3"	1-9/16"
CF36U	14	Chicago Faucet	2-1/2"	1-9/16"
CG30U	15	Cleveland Faucet	2-1/4"	1-3/8"
CG40U	15	Cleveland Faucet	2-1/2"	1-9/16"
CG45U	15	Cleveland Faucet	3"	1-9/16"
CG50U	15	Cleveland Faucet	2-15/16"	1-9/16"
DZ60U	16	Danze	5"	1-3/4"
DZ61U	16	Danze	3-3/4"	1-3/4"
DZ62U	16	Danze	5"	1-1/2"
DZ63U	16	Danze	5-7/16"	1-1/2"
DZ64U	16	Danze	5-7/16"	1-1/2"
DZ65U	17	Danze	5-3/4"	1-3/4"
DZ66U	17	Danze	4"	1-1/2"



SINGLE LEVER CERAMIC CARTRIDGES (ALPHABETICAL ORDER BY MANUFACTURE)



CARTRIDGE	PAGE No.	CARTRIDGE BRAND	HEIGHT	WIDTH
DZ67U	17	Danze	5-1/2"	1-9/16"
DZ68U	17	Danze	4"	1-7/16"
DZ69U	17	Danze	2-1/8"	1-7/16"
DE60U	18	Delta	4-3/8"	1-15/16"
DE65U	18	Delta	3-3/4"	1-15/16"
40130004	18	Delta	2"	1-1/2"
40130178	19	Delta	3-1/4"	1-7/8"
40130056	19	Delta	4-1/8"	1-15/16"
40130187	19	Delta	3-3/16"	1-7/8"
40130007	19	Delta	2-1/2"	1-3/8"
EK11U	20	Elkay	3-1/4"	1-3/4"
EK12U	20	Elkay	3-1/2"	2-1/4"
EZ45U	20	EZ-Flow	2-1/2"	1-9/16"
EZ60U	20	EZ-Flow	3-1/8"	1-9/16"
DZ60U	21	Gerber	5"	1-3/4"
DZ61U	21	Gerber	3-3/4"	1-3/4"
DZ62U	21	Gerber	5"	1-1/2"
DZ63U	21	Gerber	5-7/16"	1-1/2"
DZ64U	21	Gerber	5-7/16"	1-1/2"
DZ65U	22	Gerber	5-3/4"	1-3/4"
DZ66U	22	Gerber	4"	1-1/2"
DZ67U	22	Gerber	5-1/2"	1-1/2"
DZ68U	22	Gerber	4"	1-7/16"
DZ69U	22	Gerber	2-1/8"	1-7/16"
GE45U	23	Gerber	2-1/4"	2-1/4"
GE60U	23	Gerber	2-3/8"	1-9/16"
GE65U	23	Gerber	3-9/16"	1-3/4"
GE66U	23	Gerber	2-1/8"	1-5/8"
GE70U	23	Gerber	3-9/16"	1-3/4"

SINGLE LEVER CERAMIC CARTRIDGES (ALPHABETICAL ORDER BY MANUFACTURE)



CARTRIDGE	PAGE No.	CARTRIDGE BRAND	HEIGHT	WIDTH
24670	24	Kohler	1-13/16"	1-15/16"
40140110	24	Kohler	3-3/8"	3"
40211333	24	Kohler	3-3/16"	2-13/16"
40140192	25	Kohler	3-5/8"	2-15/16"
40140177	25	Kohler		
KO31U / 40140122	26	Kohler	2-13/16"	1-3/8"
KO35U	26	Kohler	2-1/4"	1-3/8"
KO36U	26	Kohler	2-13/16"	1-3/8"
KO37U	26	Kohler	1-15/16"	1"
KO42U	26	Kohler	2-1/4"	1-1/4"
KO70U	26	Kohler	3-11/16"	2"
KO71U	26	Kohler	3-11/16"	2"
KO75U	25	Kohler	4-1/4"	4-3/8"
KO76U	25	Kohler	2"	2-13/16"
40100253	27	Marlin	2-1/4"	1-3/8"
40100254	27	Marlin	2-1/2"	1-9/16"
40100255	27	Marlin	15/16"	1-1/2"
EZ-70U	27	Marlin	3-9/16"	1-9/16"
MN60U	28	Matco Norca	5-3/8"	1-9/16"
40140021	28	Moen	2-1/16"	1-1/8"
NI9U / 40150148	28	Nibco	4"	1-3/4"
PE60U	28	Peerless / Delta	3-1/16"	1-9/16"
23073	28	Peerless / Delta	5/8"	1-1/2"
PH30U	28	Phoenix	2-5/8"	1-1/2"
PP33U	29	Price Pfister	2-1/4"	1-3/8"
PP41U	29	Price Pfister	2-1/2"	1-9/16"
PP42U	29	Price Pfister	2-1/2"	1-7/16"
PP46U	29	Price Pfister	3"	1-9/16"
PP47U	29	Price Pfister	1-15/16"	1"



SINGLE LEVER CERAMIC CARTRIDGES (ALPHABETICAL ORDER BY MANUFACTURE)



CARTRIDGE	PAGE No.	CARTRIDGE BRAND	HEIGHT	WIDTH
PP65U	30	Price Pfister	4-1/8"	2-5/16"
PP66U	30	Price Pfister	4-1/8"	2-5/16"
PP67U	30	Price Pfister	4-1/2"	2-5/16"
PP70U	30	Price Pfister	2-1/2"	1-11/16"
SA45U	31	Sayco	2-1/2"	1-1/2"
SA75U	31	Sayco	2-15/16"	1-1/2"
SA76U	31	Sayco	2-15/16"	1-1/2"
40150146	31	Speakman	3-15/16"	1-1/8"
40170021	32	Speakman	4-1/4"	3-1/8"
27752	32	Speakman	2-3/8"	1-7/8"
40171044	32	Speakman	4-3/8"	2"
SP75U	32	Speakman	5-1/8"	2"
SF48U	33	Sterling Faucet	2-7/16"	1-1/4"
SF49U	33	Sterling Faucet	2-7/16"	1-1/4"
SF61U	33	Sterling Faucet	2-15/16"	2-13/16"
SF62U	33	Sterling Faucet	2-9/16"	2-13/16"
TS40U	34	T&S Brass	3"	1-9/16"
TS45U	34	T&S Brass	2-1/2"	1-9/16"
TS60U	34	T&S Brass	3-3/8"	1-9/16"
SY30U	34	Symmons	2-1/4"	1-3/8"
40160098 / 211503	35	Valley	2-1/4"	1-7/16"
40160108 / 211629	35	Valley	2-5/8"	1-15/16"
40160136 / VA45U	35	Valley	3-15/16"	1-5/8"
ZU45U	35	Zurn	2-3/8"	1-1/2"
ZU48U	35	Zurn	2-3/4"	1-3/8"
ZU73U	35	Zurn	3-1/8"	1-1/2"

(2) HANDLE CERAMIC STEMS BY SIZE

HEIGHT MEASUREMENT	PAGE No.	STEM	STEM BRAND	WIDTH MEASUREMENT	SPLINE COUNT	SPLINE WIDTH
1-1/2"	37	UB30U	Union Brass	7/8"	30	3/8"
1-5/8"	37	IB35U	Indiana Brass	15/16"	18	3/8"
1-5/8"	37	SA30U	Sayco	1"	16	3/8"
1-5/8"	37	SA40U	Sayco	1"	16	3/8"
1-3/4"	37	AS32U	Am/Standard	1-11/16"	Split	3/8"
1-3/4"	37	RB30U	Royal Brass	15/16"	16	3/8"
1-13/16"	37	CB25U	Central Brass	7/8"	16	3/8"
1-13/16"	37	GE30U	Gerber	1"	16	3/8"
1-13/16"	37	PM30U	Premier	1"	12	3/8"
1-7/8"	38	CG20U	Cleveland Faucet	15/16"	^D Spline	5/16"
1-7/8"	38	KO30U	Kohler	15/16"	Square	5/16"
1-7/8"	38	PP20U	Price Pfister	15/16"	11	3/8"
1-15/16"	38	23051	Delex	15/16"	^D Spline	5/16"
1-15/16"	38	GB30U	Glacier Bay	7/8"	^D Spline	5/16"
1-15/16"	38	GB40U	Glacier Bay	7/8"	^D Spline	5/16"
1-15/16"	38	40100250 40100251	Marlin	15/16"	^D Spline	5/16"
1-15/16"	38	GB31U	Glacier Bay	7/8"	24	3/8"
1-15/16"	38	GB35U	Glacier Bay	7/8"	^D Spline	1/4"
2"	38	AS33U	Am/Standard	15/16"	Square	3/8"
2"	38	PP32U	Price Pfister	13/16"	12	3/8"
2"	38	PP35U	Price Pfister	1"	12	3/8"
2"	39	SI30U	Sisco	15/16"	24	3/8"
2"	39	SP30U	Speakman	15/16"	20	3/8"
2"	39	SF31U	Sterling Faucet	15/16"	^D Spline	5/16"
2-1/16"	39	40451043 40451044	Marlin	15/16"	22	5/16"
2-1/16"	39	BD3U	Broadway	15/16"	20	7/16"
2-1/16"	39	EL25U	Elkay	15/16"	20	5/16"
2-1/16"	39	EZ20U	EZ-Flow	15/16"	^D Spline	5/16"
2-1/16"	39	UR25U	Universal Rundle	15/16"	20	5/16"



(2) HANDLE CERAMIC STEMS BY SIZE

HEIGHT MEASUREMENT	PAGE No.	STEM	STEM BRAND	WIDTH MEASUREMENT	SPLINE COUNT	SPLINE WIDTH
2-1/8"	39	BZ30U	Brizo	15/16"	20	5/16"
2-1/8"	39	BD2U	Broadway	15/16"	20	5/16"
2-1/8"	39	DT30U	DornBracht	15/16"	20	5/16"
2-1/8"	40	EK25U	Elkay	15/16"	20	5/16"
2-1/8"	40	EK30U	Elkay	15/16"	20	5/16"
2-1/8"	40	HG30U	Hans Grohe	15/16"	20	5/16"
2-1/8"	40	KT30U	Kallista	15/16"	20	3/8"
2-1/8"	40	KT35U	Kallista	15/16"	20	3/8"
2-1/8"	40	KO40U	Kohler	1"	20	5/16"
2-1/8"	41	PY30U	Phylrich	15/16"	16	3/8"
2-1/8"	39	SI35U	Sisco	7/8"	24	5/16"
2-1/8"	41	SN30U	Santec	15/16"	16	3/8"
2-1/8"	40	SY35U	Symmons	15/16"	20	5/16"
2-1/8"	41	40170213 40170214	Marlin	15/16"	20	5/16"
2-3/16"	41	AS31U	Am/Standard	1"	18	5/16"
2-3/16"	41	BD1U	Broadway	1-1/8"	20	5/16"
2-3/16"	41	CF30U	Chicago Faucet	1"	Square	7/16"
2-3/16"	41	JD30U	Jado	15/16"	20	5/16"
2-3/16"	42	KB30U	Kingston Brass	15/16"	15	3/8"
2-3/16"	42	MA30U	Marlin	15/16"	32	3/8"
2-3/16"	42	SE30U	Sepco	15/16"	15	3/8"
2-3/16"	42	ZU20U	Zurn	15/16"	Square	3/8"
2-1/4"	42	EK32U	Elkay	15/16"	12	3/8"
2-1/4"	42	GR20U	Grohe	1"	20	5/16"
2-1/4"	42	KO45U	Kohler	1-1/16"	24	5/16"
2-1/4"	43	SF32U	Sterling Faucet	1"	16	3/8"
2-1/4"	43	UR32U	Universal Rundle	15/16"	12	3/8"
2-5/16"	43	AS41U	Am/Standard	1-1/16"	^D Spline	5/16"
2-5/16"	43	HB30U	Hans Grohe	15/16"	16	3/8"

(2) HANDLE CERAMIC STEMS BY SIZE







HEIGHT MEASUREMENT	PAGE No.	STEM	STEM BRAND	WIDTH MEASUREMENT	SPLINE COUNT	SPLINE WIDTH
2-3/8"	43	AT30U	Altmans	7/8"	16	3/8"
2-3/8"	43	DE35U	DELTA	7/8"	16	3/8"
2-3/8"	43	DT35U	DornBracht	1-1/8"	20	5/16"
2-3/8"	44	DT40U	DornBracht	15/16"	20	5/16"
2-3/8"	44	SE35U	Sepco	15/16"	13	3/8"
2-3/8"	44	SP32U	Speakman	15/16"	20	3/8"
2-1/2"	44	KO46U	Kohler	7/8"	19	7/16"
2-1/2"	44	SE40U	Sepco	1-1/8"	15	3/8"
2-1/2"	44	SG30U	Supergrif	1"	20	5/16"
2-1/2"	44	SG35U	Supergrif	15/16"	20	5/16"
2-9/16"	44	PY35U	Phylrich	15/16"	16	3/8"
2-9/16"	45	SG40U	Supergrif	1-1/8"	20	5/16"
2-9/16"	45	KO44U	Kohler	13/16"	19	7/16"
2-5/8"	45	SN35U	Santec	15/16"	16	5/16"
2-5/8"	45	SE45U	Sepco	15/16"	15	3/8"
2-5/8"	45	SM30U	Sigma/Altmans	15/16"	16	3/8"
2-5/8"	45	GB45U	Glacier Bay	1-1/8"	24	3/8"
2-11/16"	45	KO41U	Kohler	15/16"	20	5/16"
2-11/16"	45	PY40U	Phylrich	15/16"	16	3/8"
2-3/4"	46	AT40U	Altmans	15/16"	16	5/16"
2-3/4"	46	AS54U	Am/Standard	1-1/8"	Split	3/8"
2-3/4"	46	EL30U	Eljer	1"	20	5/16"
2-13/16"	46	AT35U	Altmans	1-1/8"	16	3/8"
2-7/8"	46	CF40U	Chicago Faucet	1"	Square	7/16"
2-7/8"	46	WB30U	Wolverine Brass	1"	16	3/8"
2-7/8"	47	ZU30U	Zurn	15/16"	Square	3/8"
2-15/16"	47	DT45U	Dornbracht	1-1/8"	20	5/16"
2-15/16"	47	PY45U	Phylrich	15/16"	16	3/8"
3"	47	PY46U	Phylrich	7/8"	16	3/8"



(2) HANDLE CERAMIC STEMS BY SIZE

HEIGHT MEASUREMENT	PAGE No.	STEM	STEM BRAND	WIDTH MEASUREMENT	SPLINE COUNT	SPLINE WIDTH
3"	47	39999629	Zurn	15/16"	Square	15/16"
3-1/16"	47	TS30U	T&S Brass	15/16"	20	7/16"
3-1/8"	47	PY55U	Phylrich	15/16"	16	3/8"
3-1/4"	48	SP36U	Speakman	15/16"	20	3/8"
3-5/16"	48	UB44U	Union Brass	1"	16	3/8"
3-3/8"	48	BD4U	Broadway	1-1/8"	20	7/16"
3-3/8"	48	PY56U	Phylrich	7/8"	16	3/8"
3-3/8"	48	AS67DU	Am/Standard	15/16"	D-spline	1/4"
3-7/16"	48	DT50U	Dornbracht	15/16"	20	5/16"
3-1/2"	48	BD5U	Broadway	15/16"	20	5/16"
3-1/2"	49	HD1U	Harden Brass	15/16"	16	3/8"
3-1/2"	49	PY60U	Phylrich	15/16"	16	3/8"
3-5/8"	49	EL40U	Eljer	15/16"	20	5/16"
3-5/8"	50	SP72U	Speakman	15/16"	20	3/8"
4"	50	SF33U	Sterling Faucet	1-1/16"	Square	5/16"
4-1/8"	50	AS55U	Am/Standard	1"	18	3/8"
4-1/4"	51	KO75U	Kohler	15/16"	16	3/8"
4-1/4"	51	WB60U	Wolverine Brass	1"	15	3/8"
4-3/8"	51	UR75U	Universal Rundle	15/16"	20	5/16"
4-1/2"	52	PP45U	Price Pfister	1-1/8"	12	3/8"
4-1/2"	52	SF58U	Sterling Faucet	1"	Square	5/16"
4-5/8"	53	PP75U	Price Pfister	1-3/16"	12	3/8"
4-3/4"	53	SA70U	Sayco	15/16"	16	3/8"
4-7/8"	53	PY70U	Phylrich	15/16"	16	3/8"
5-1/4"	54	CB71U	Central Brass	7/8"	16	3/8"
5-1/2"	54	GE75U	Gerber	1-1/8"	16	3/8"

THERMOSTATIC MIXING VALVES

HEIGHT MEASUREMENT	PAGE No.	STEM	STEM BRAND	SPLINE COUNT	SPLINE	SPLINE SIZE
4-3/4"	56	GR80U	Grohe	N/A	Round	N/A
3-7/8"	56	GR81U	Grohe	N/A	Round	N/A
3-1/4"	56	GR82U	Grohe	N/A	Round	N/A
5-7/16"	56	GR83U	Grohe	N/A	D-Spline	1/2"
4-9/16"	57	GR84U	Grohe	N/A	D-Spline	1/2"
4-3/8"	57	GR85U	Grohe	N/A	Round	N/A
3-1/4"	57	GR86U	Grohe	N/A	D-Spline	1/2"
5"	57	GR87U	Grohe	N/A	D-Spline	1/2"
4-1/8"	58	GR88U	Grohe	N/A	Round	N/A
4"	58	GR89U	Grohe	N/A	Round	N/A
5-1/4"	58	HG80U	Hans Grohe	36		N/A
4-1/2"	58	HG81U	Hans Grohe	36		N/A
3-3/4"	59	HG82U	Hans Grohe	20		N/A
3-3/4"	59	HG83U	Hans Grohe	20		N/A
4"	59	KO80U	Kohler	20		N/A
4"	59	MO80U	Moen	20		N/A

AMERICAN STANDARD

AS34U

**HEIGHT 2-3/16"
WIDTH 1-9/16"**

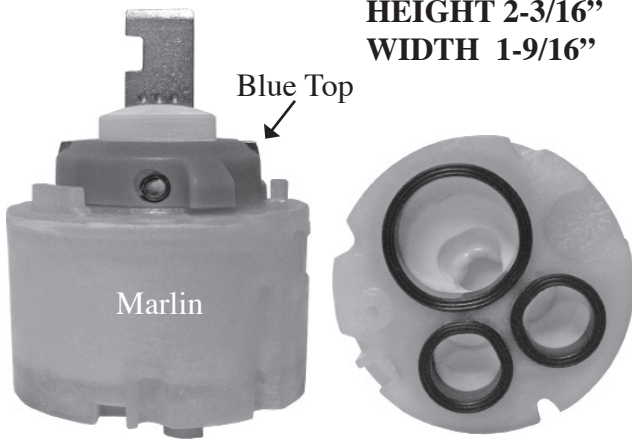

AMERICAN STANDARD

AS35U

**HEIGHT 2-3/16"
WIDTH 1-5/16"**



AMERICAN STANDARD

AS36U

**HEIGHT 2-3/16"
WIDTH 1-9/16"**

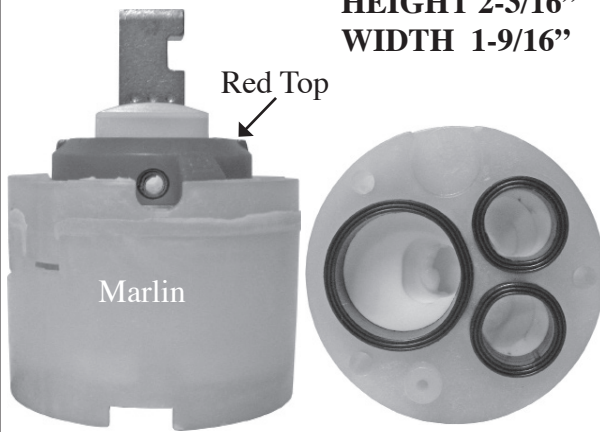

AMERICAN STANDARD

AS40U

**HEIGHT 2-1/4"
WIDTH 1-13/16"**

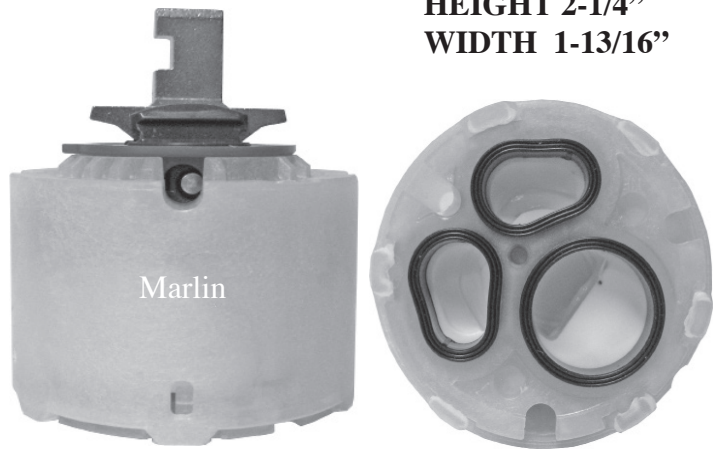

AMERICAN STANDARD

AS46U

**HEIGHT 2-1/4"
WIDTH 1-13/16"**

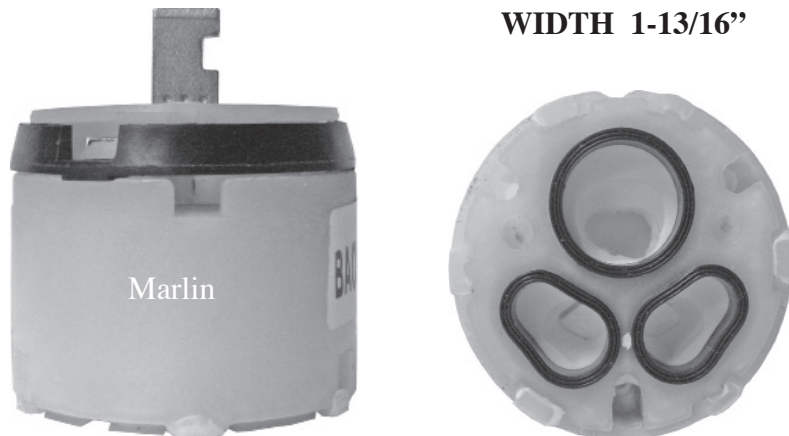

AMERICAN STANDARD

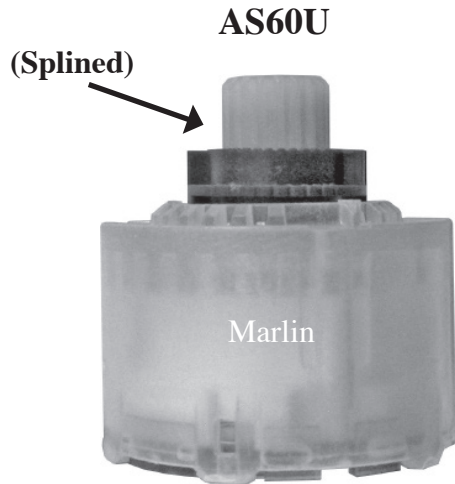

HEIGHT 2-1/8"
WIDTH 1-13/16"



AMERICAN STANDARD

AS61U

(AFTER JUNE 2000)



HEIGHT 2-7/16"
WIDTH 1-15/16"

TOP VIEW
WIDTH 2"



AMERICAN STANDARD

AS90U

HEIGHT 2-13/16"
WIDTH 1-15/16"

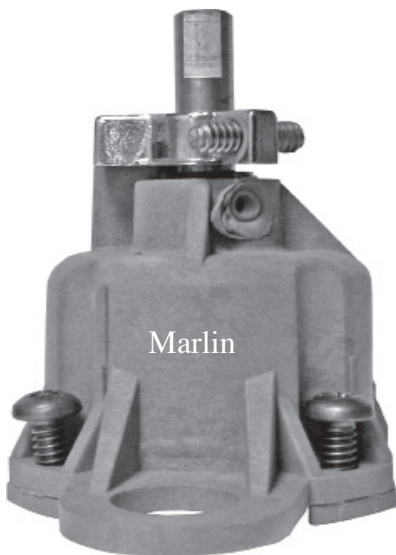

AMERICAN STANDARD

SINGLE HOLE

2609

**HEIGHT 1-7/8"
WIDTH 2-5/16"**

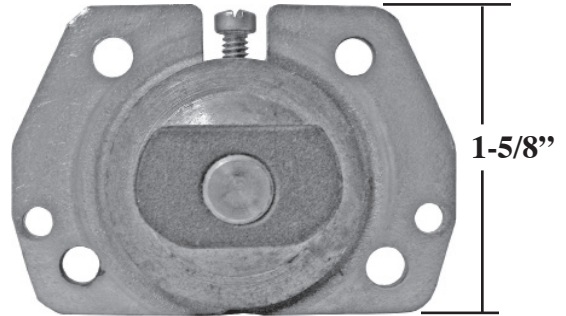
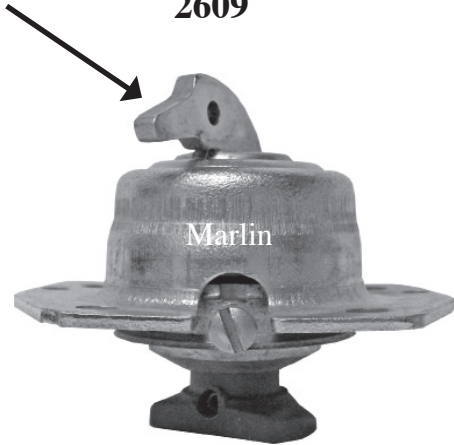

AMERICAN STANDARD

40120439

**HEIGHT 2-3/16"
WIDTH 1-13/16"**



AMERICAN STANDARD

DOUBLE HOLE

2811

**HEIGHT 2"
WIDTH 2-5/16"**

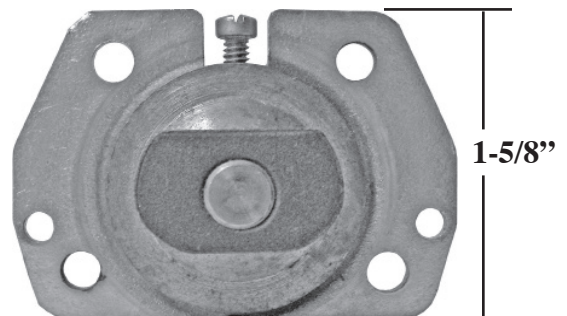
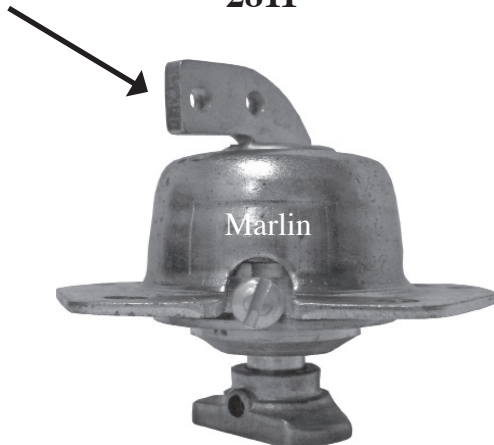

AMERICAN STANDARD

40120700



HEIGHT 2-7/16"
WIDTH 2-1/8"



AMERICAN STANDARD

21563

(AFTER JUNE 1995)

TOP VIEW
WIDTH 2-3/8"



HEIGHT 2-5/16"
WIDTH 2-3/8"



AMERICAN STANDARD

40123061

(BEFORE JUNE 1995)

TOP VIEW
WIDTH 2-1/16"



HEIGHT 2-1/8"
WIDTH 2-9/16"

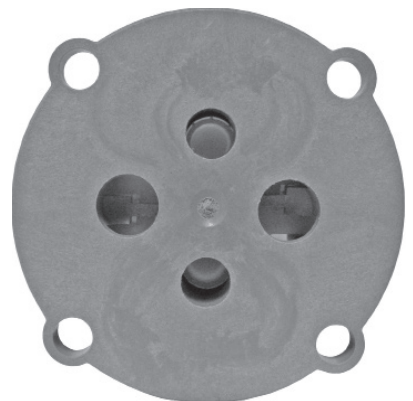

BEHAVIOR SAFETY

27780 (BSP)

HEIGHT 4"
WIDTH 1-1/2"
Spline
Count **38**



CHICAGO FAUCET

CF35U

HEIGHT 3"
WIDTH 1-9/16"



CHICAGO FAUCET

CF36U

HEIGHT 2-1/2"
WIDTH 1-9/16"

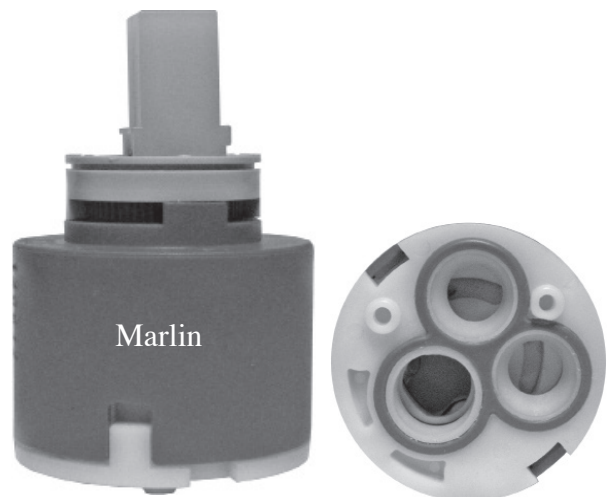

CLEVELAND FAUCET

CG30U



HEIGHT 2-1/4"
WIDTH 1-3/8"



CLEVELAND FAUCET

CG40U



HEIGHT 2-1/2"
WIDTH 1-9/16"



CLEVELAND FAUCET

CG45U



HEIGHT 3"
WIDTH 1-9/16"



CLEVELAND FAUCET

CG50U

ADAPTOR



HEIGHT 2-15/16"
WIDTH 1-9/16"

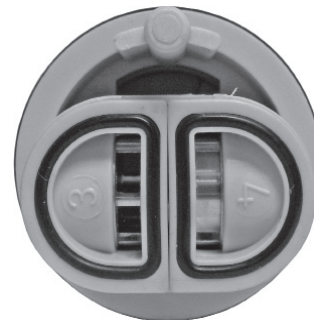

DANZE

DZ60U HEIGHT 5"
WIDTH 1-3/4"
Spline
Count 38



(Not Actual Size)

DANZE

DZ61U HEIGHT 3-3/4"
WIDTH 1-3/4"
Square
Spline



DANZE

DZ62U HEIGHT 5"
WIDTH 1-1/2"
Square
Spline



(Not Actual Size)

DZ63U

DANZE

HEIGHT 5-7/16"
WIDTH 1-1/2"
Spline
Count 38



(Not Actual Size)

DZ64U

DANZE

HEIGHT 5-7/16"
WIDTH 1-1/2"
Square
Spline



DANZE

DZ65U

HEIGHT 5-3/4"

WIDTH 1-3/4"

Spline
Count **38**

(Not Actual Size)



DANZE

DZ66U

HEIGHT 4"

WIDTH 1-1/2"

Spline
Count **16**



DANZE

DZ67U

HEIGHT 5-1/2"

WIDTH 1-1/2"

Square
Spline

(Not Actual Size)



DANZE

DZ68U

HEIGHT 4"

WIDTH 1-7/16"

Spline
Count **38**



DANZE

DZ69U

HEIGHT 2-1/8"

WIDTH 1-7/16"

Square
Spline



DELTA

DE60U

**HEIGHT 4-3/8"
WIDTH 1-15/16"**

For "Multichoice"
Delta Series 13 & 14



Gray
Bottom

DELTA

DE65U

**HEIGHT 3-3/4"
WIDTH 1-15/16"**

For "Multichoice"
Delta 17 Series



DELTA

40130004

**HEIGHT 2"
WIDTH 1-1/2"**

For Delta
"Scald Guard"



DELTA

40130178

**HEIGHT 3-1/4"
WIDTH 1-7/8"**



For "Monitor"
1,500 Series



DELTA

40130187

**HEIGHT 3-3/16"
WIDTH 1-7/8"**



For "Monitor"
1,700 Series



DELTA

40130056

**HEIGHT 4-1/8"
WIDTH 1-15/16"**

For "Monitor"
1,300 & 1,400
Series



Blue
Bottom

DELTA

40130007

**HEIGHT 2-1/2"
WIDTH 1-3/8"**



ELKAY

EK11U

HEIGHT 3-1/4"
WIDTH 1-3/4"



ELKAY

EK12U

HEIGHT 3-1/2"
WIDTH 2-1/4"



E-Z FLOW

EZ45U

HEIGHT 2-1/2"
WIDTH 1-9/16"



E-Z FLOW

EZ60U

HEIGHT 3-1/8"
WIDTH 1-9/16"



GERBER

DZ60U HEIGHT 5"
WIDTH 1-3/4"
Spline
Count 38

(Not Actual Size)



GERBER

DZ61U HEIGHT 3-3/4"
WIDTH 1-3/4"
Square
Spline



GERBER

DZ62U HEIGHT 5"
WIDTH 1-1/2"
Square
Spline

(Not Actual Size)



DZ63U

GERBER

HEIGHT 5-7/16"
WIDTH 1-1/2"
Spline
Count 38

(Not Actual Size)



DZ64U

GERBER

HEIGHT 5-7/16"
WIDTH 1-1/2"
Square
Spline



GERBER

DZ65U
HEIGHT 5-3/4"
WIDTH 1-3/4"
Spline Count **38**

(Not Actual Size)



GERBER

DZ66U
HEIGHT 4"
WIDTH 1-1/2"
Spline Count **16**



GERBER

DZ67U
HEIGHT 5-1/2"
WIDTH 1-1/2"
Square Spline

(Not Actual Size)



GERBER

DZ68U
HEIGHT 4"
WIDTH 1-7/16"
Spline Count **38**



GERBER

DZ69U
HEIGHT 2-1/8"
WIDTH 1-7/16"
Square Spline



GERBER

GE45U

**HEIGHT 2-1/4"
WIDTH 1-3/8"**



GERBER

GE66U

**HEIGHT 2-1/8"
WIDTH 1-5/8"
BOTTOM 1-3/16"**



GE70U

**HEIGHT 3-9/16"
WIDTH 1-3/4"
BOTTOM 1-11/16"**
(Inside Top View)

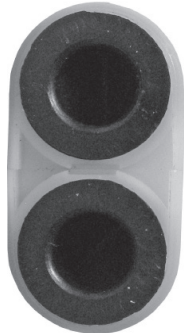
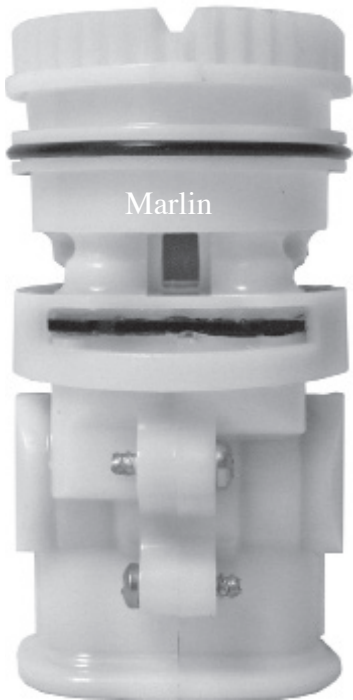

GE65U

**HEIGHT 3-9/16"
WIDTH 1-3/4"
BOTTOM 1-11/16"**
(Inside Top View)

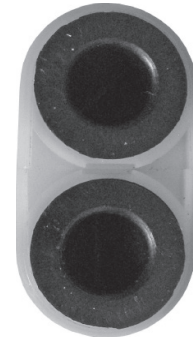
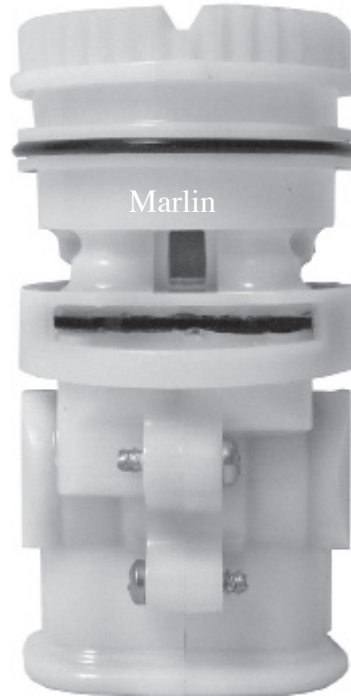

NOTE:

(GE45U & GE70U) WORK TOGETHER

(GE65U & GE66U) WORK TOGETHER

**BALANCING SPOOL FOR THE
(GE60U) IS PART # 212083**

GERBER (SAFE-TEMP)

GE60U

**HEIGHT 2-3/8"
WIDTH 1-9/16"**
BALANCING SPOOL
Part. No. 218083



KOHLER

40140110
(24574) **HEIGHT 3-3/8"**
WIDTH 3"

Brass Spline

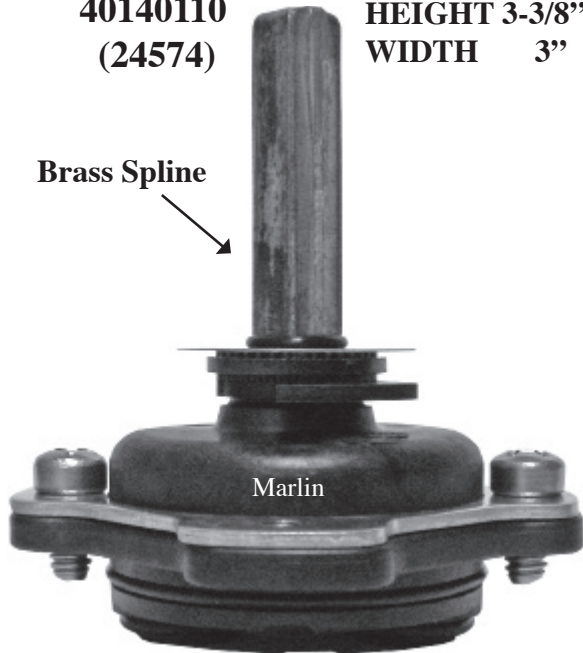

40140110 & **40211333**
(24574) & (24600)
Both Caps use the
Balance Assembly
24670
(After 2018)

Replacement →



N.L.A
(Before 2018)

New Style!



Cat. No. 24670
(After 2018)



Top View

KOHLER

40211333
(24600) **HEIGHT 3-3/16"**
WIDTH 2-13/16"

Plastic Spline

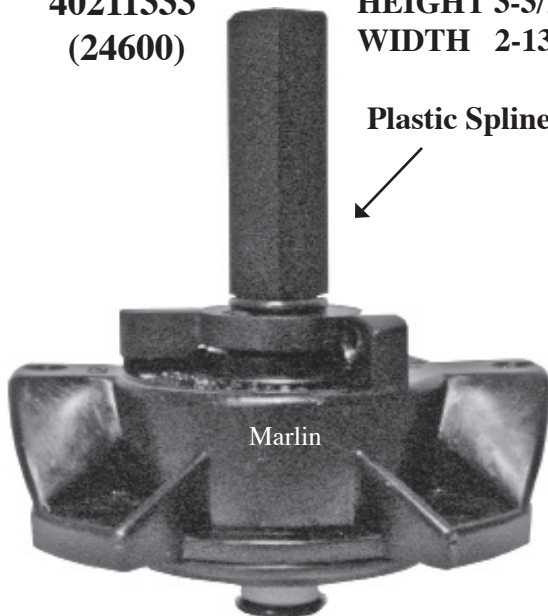

KOHLER

(40140192) Kit

Includes Everything

HEIGHT 3-5/8"
WIDTH 2-15/16"

NOTE:
40140177
Top Cap
Assembly Only

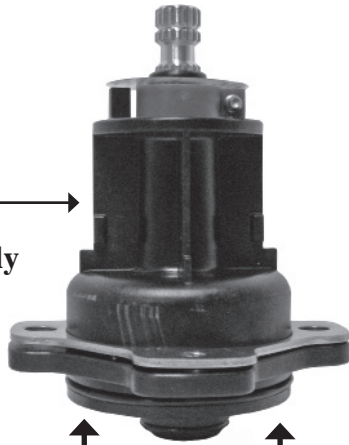

24670
Balance
Assembly
Only
(After 2018)



KOHLER

KO75U

HEIGHT 4-1/4"
WIDTH 4-3/8"

Top Cap
Assembly

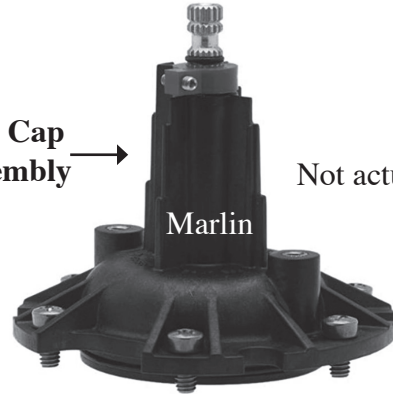

Not actual size

Bottom
View

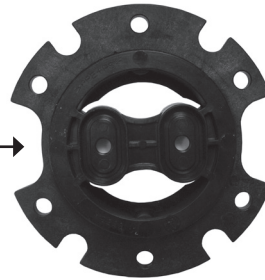

KOHLER

24671

HEIGHT 4-5/8"
WIDTH 2-1/2"



KOHLER

KO76U

HEIGHT 2"
WIDTH 2-13/16"

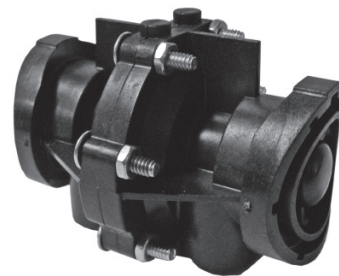

Bottom
View

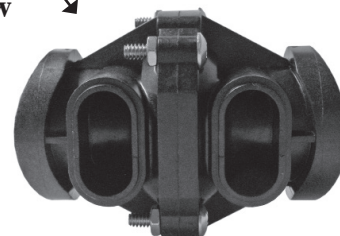

KOHLER

**40140122
(KO31U)**

**HEIGHT 2-13/16"
WIDTH 1-3/8"**



KOHLER

KO35U

**HEIGHT 2-1/4"
WIDTH 1-3/8"**

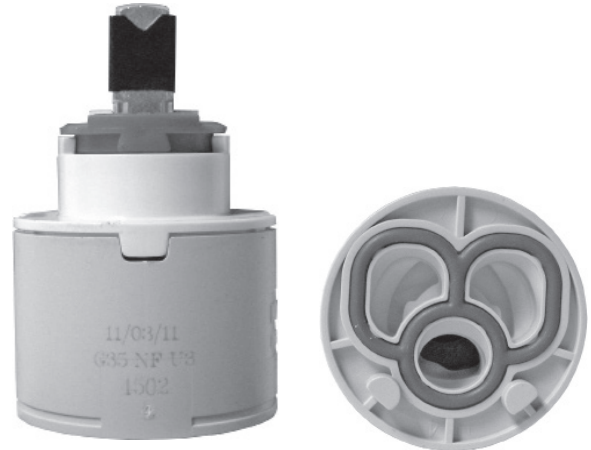

KO36U KOHLER

**HEIGHT 2-13/16"
WIDTH 1-3/8"**



KO37U KOHLER

**HEIGHT 1-15/16"
WIDTH 1"**



KO42U KOHLER

**HEIGHT 2-1/4"
WIDTH 1-1/4"**



KOHLER

KO70U

**LARGE FLOW
HEIGHT 3-11/16"
WIDTH 2"**

(Not Actual size)



KOHLER

KO71U

**LOW FLOW
HEIGHT 3-11/16"
WIDTH 2"**

(Not Actual size)



MARLIN CORAL COLLECTION

MARLIN CORAL COLLECTION



40100255

40100254



HEIGHT 15/16"
WIDTH 1-1/2"

HEIGHT 2-1/2"
WIDTH 1-9/16"

TUB & SHOWER

Bottom

Top

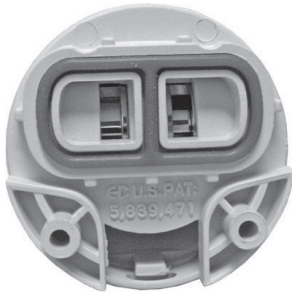

MARLIN CORAL COLLECTION

MARLIN CORAL COLLECTION

40100253

EZ-70U

LAVATORY

HEIGHT 2-1/4"
WIDTH 1-3/8"

HEIGHT 3-9/16"
WIDTH 1-9/16"

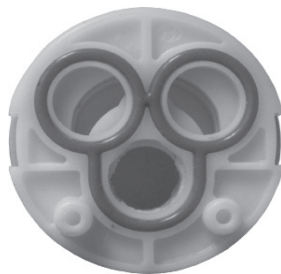

MATCO NORCA

MN60U

**HEIGHT 5-3/8"
WIDTH 1-9/16"**

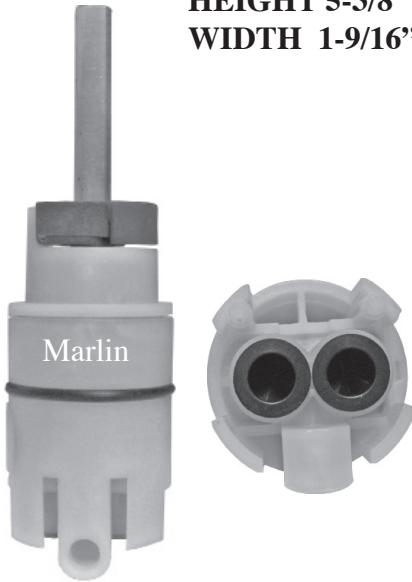

MOEN

40140021

**HEIGHT 2-1/16"
WIDTH 1-1/8"**

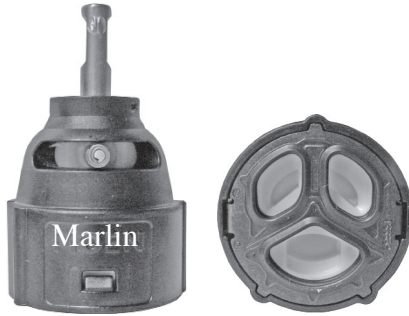

MOEN

40140193

**HEIGHT 4-1/8"
WIDTH 15/16"**

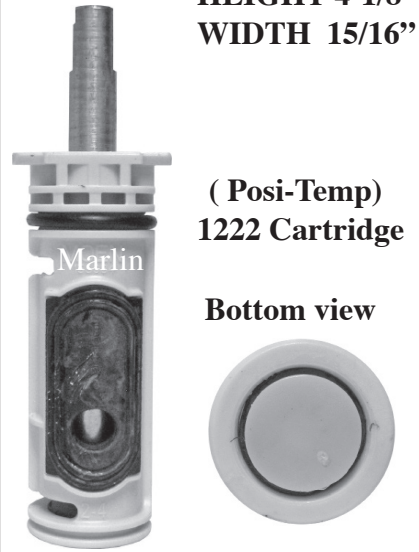

NIBCO

**40150148
(NI9U)**

**HEIGHT 4"
WIDTH 1-3/4"**



PEERLESS-DELTA

PE60U

**HEIGHT 3-1/16"
WIDTH 1-9/16"**



PEERLESS-DELTA

23073

**HEIGHT 5/8"
WIDTH 1-1/2"**

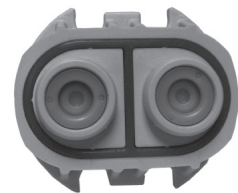

Use with 23073
Check Assembly

PH30U

PHOENIX

**HEIGHT 2-5/8"
WIDTH 1-1/2"**



PRICE PFISTER

PP33U



**HEIGHT 2-1/4"
WIDTH 1-3/8"**



PRICE PFISTER

PP41U



**HEIGHT 2-1/2"
WIDTH 1-9/16"**

"For Kitchen Faucets"



PRICE PFISTER

PP42U



**HEIGHT 2-1/2"
WIDTH 1-7/16"**



PRICE PFISTER

PP46U



**HEIGHT 3"
WIDTH 1-9/16"**



PRICE PFISTER

PP47U



**HEIGHT 1-15/16"
WIDTH 1"**



PRICE PFISTER

PP65U

HEIGHT 4-1/8"
WIDTH 2-5/16"
BASE 1-5/8"



PRICE PFISTER

PP66U

HEIGHT 4-1/8"
WIDTH 2-5/16"
BASE 1-5/8"

(BRASS STEM)



PRICE PFISTER

PP67U

HEIGHT 4-1/2"
WIDTH 2-5/16"
BASE 1-5/8"



PRICE PFISTER

PP70U

HEIGHT 2-1/2"
WIDTH 1-11/16"

(ROMAN TUB)



SAYCO

SA45U

**HEIGHT 2-1/2"
WIDTH 1-1/2"**



SAYCO

SA75U

**HEIGHT 2-15/16"
WIDTH 1-1/2"**



(Pressure Balance)



SAYCO

SA76U

**HEIGHT 2-15/16"
WIDTH 1-1/2"**

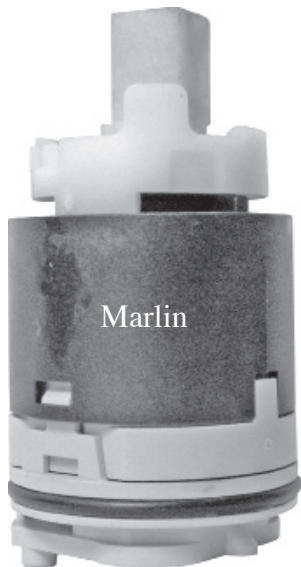

(Pressure Balance)



SPEAKMAN

40150146

**HEIGHT 3-15/16"
WIDTH 1-1/8"**



Bottom view

SPEAKMAN

40170021

HEIGHT 4-1/4"
WIDTH 3-1/8"

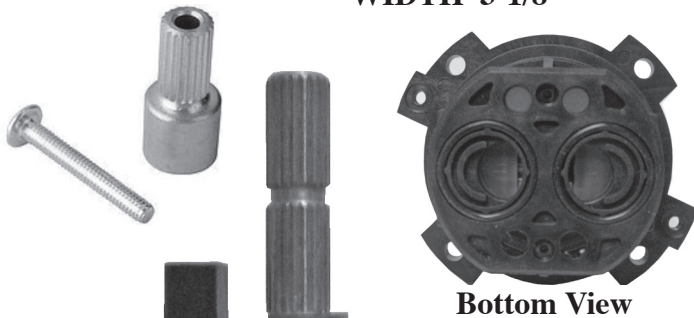

Bottom View

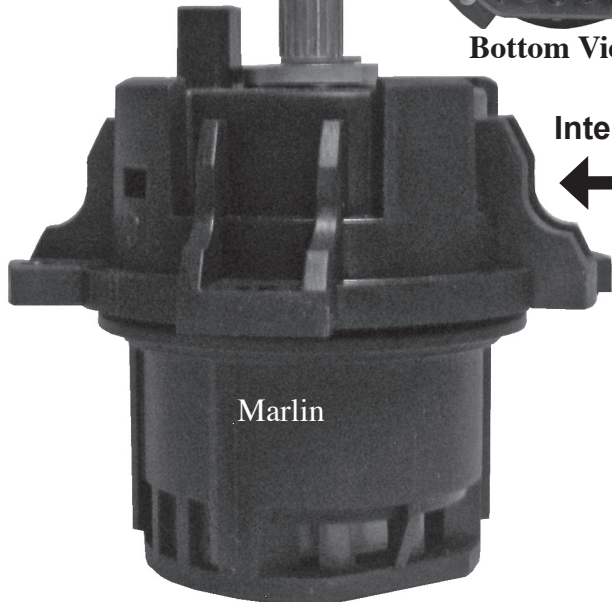

"Current Design"

Interchangeable



SPEAKMAN

SP75U

HEIGHT 5-1/8"
WIDTH 2"

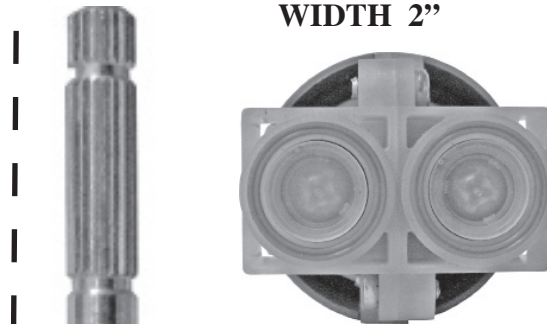

Bottom View

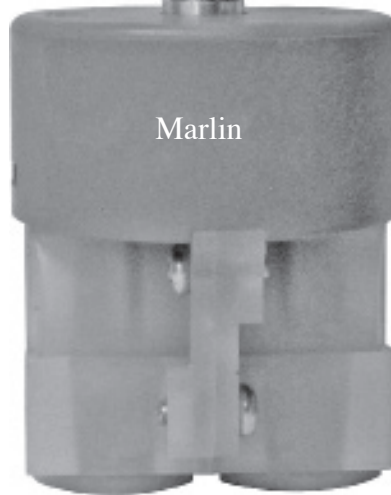

"New Style"

USE: **40171044**
For
(Exposed Shower)
Short Stem

HEIGHT 4-3/8"
WIDTH 2"
"New Style"

Interchangeable

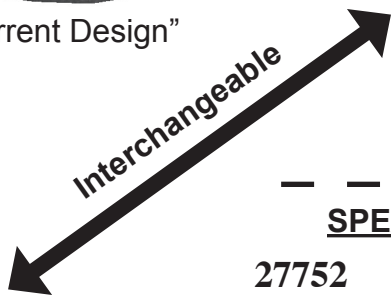

SPEAKMAN

27752

HEIGHT 2-3/8"
WIDTH 1-7/8"

Regulating Module



"Old Style"



Top View



Side View



STERLING FAUCET

SF48U

HEIGHT 2-7/16"
WIDTH 1-1/4"



**Lav, Tub
& Kitchen
Less Spray**



STERLING FAUCET

SF49U

HEIGHT 2-7/16"
WIDTH 1-1/4"

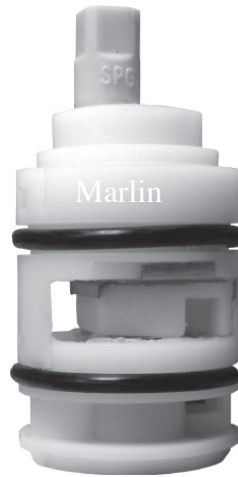

**Kitchen
With Spray**



STERLING FAUCET

SF61U

HEIGHT 2-15/16"
WIDTH 2-13/16"

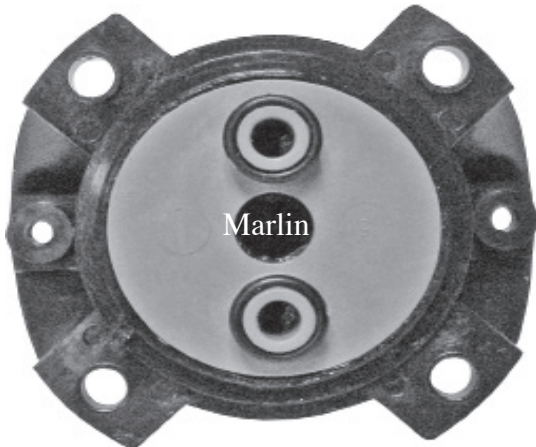
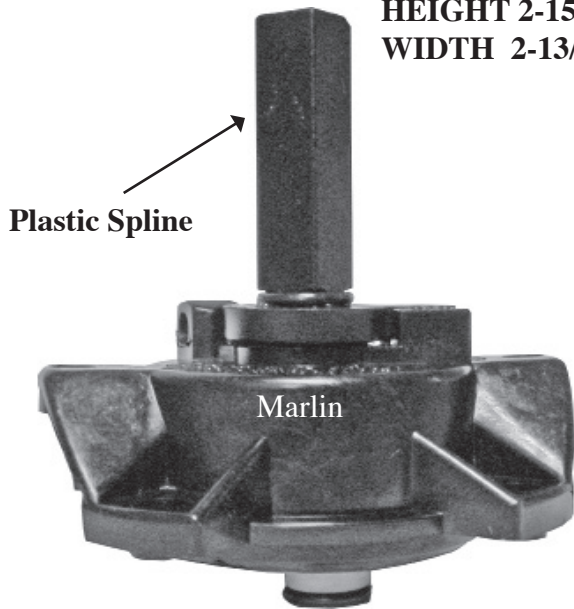

STERLING FAUCET

SF62U

HEIGHT 2-9/16"
WIDTH 2-13/16"

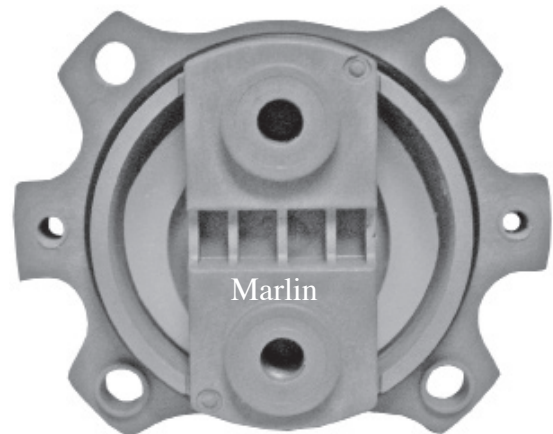
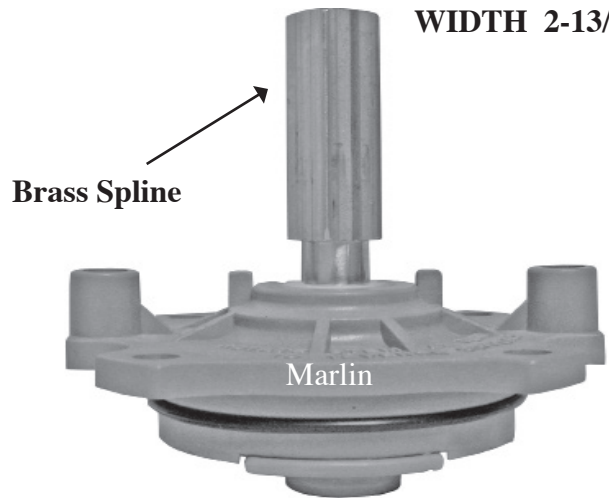

T&S BRASS

TS40U

**HEIGHT 3"
WIDTH 1-9/16"**



T&S BRASS

TS45U

**HEIGHT 2-1/2"
WIDTH 1-9/16"**



T&S BRASS

TS60U

**HEIGHT 3-3/8"
WIDTH 1-9/16"**

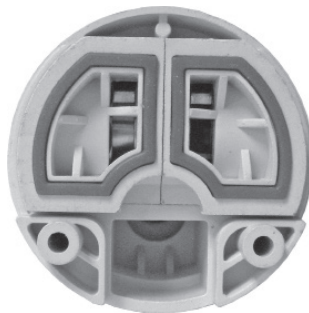

SYMMONS

SY30U

**HEIGHT 2-1/4"
WIDTH 1-3/8"**



VALLEY

40160098 HEIGHT 2-1/4"
(211503) WIDTH 1-7/16"



VALLEY

40160108 HEIGHT 2-5/8"
(211629) WIDTH 1-15/16"



VALLEY

40160136 HEIGHT 3-15/16"
(VA45U) WIDTH 1-5/8"



ZURN

ZU45U HEIGHT 2-3/8"
WIDTH 1-1/2"



ZURN

ZU48U HEIGHT 2-3/4"
WIDTH 1-3/8"



ZURN

ZU73U HEIGHT 3-1/8"
WIDTH 1-1/2"







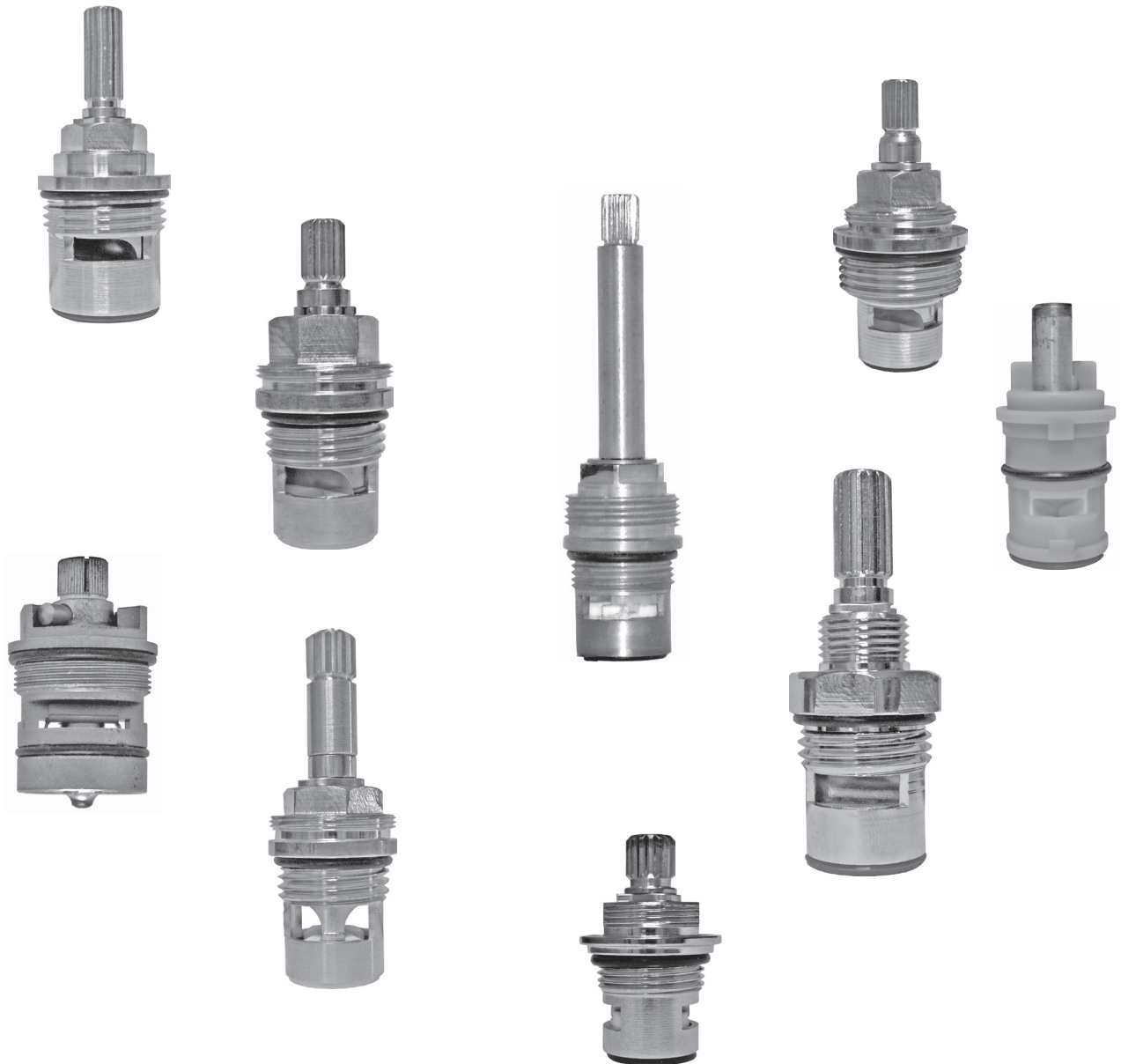







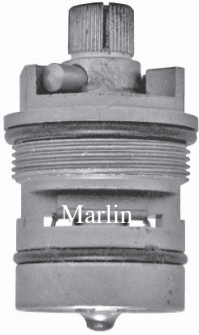







SECTION 2

TWO HANDLE CERAMIC STEMS BY SIZE















STEMS BY SIZE

<p><u>UNION BRASS</u> UB30U</p>  <p>HEIGHT..... 1-1/2" WIDTH 7/8" SPLINE COUNT... 30 SPLINE WIDTH... 3/8"</p>	<p><u>INDIANA BRASS</u> IB35U</p>  <p>HEIGHT..... 1-5/8" WIDTH 15/16" SPLINE COUNT... 18 SPLINE WIDTH... 3/8"</p>	<p><u>SAYCO</u> SA30U</p>  <p>HEIGHT..... 1-5/8" WIDTH 1" SPLINE COUNT... 16 SPLINE WIDTH... 3/8"</p>
<p><u>SAYCO</u> SA40U</p>  <p>HEIGHT..... 1-5/8" WIDTH 1" SPLINE COUNT... 16 SPLINE WIDTH... 3/8"</p>	<p><u>AM/STANDARD</u> AS32U</p> <p>Dualux</p>  <p>HEIGHT..... 1-3/4" WIDTH 1-1/16" SPLINE Split SPLINE WIDTH... 3/8"</p>	<p><u>ROYAL BRASS</u> RB30U</p>  <p>HEIGHT..... 1-3/4" WIDTH 15/16" SPLINE COUNT... 16 SPLINE WIDTH... 3/8"</p>
<p><u>CENTRAL BRASS</u> CB25U</p>  <p>HEIGHT..... 1-13/16" WIDTH 7/8" SPLINE COUNT... 16 SPLINE WIDTH... 3/8"</p>	<p><u>GERBER</u> GE30U</p>  <p>HEIGHT..... 1-13/16" WIDTH 1" SPLINE COUNT... 16 SPLINE WIDTH... 3/8"</p>	<p><u>PREMIER</u> PM30U</p>  <p>HEIGHT..... 1-13/16" WIDTH 1" SPLINE COUNT... 12 SPLINE WIDTH... 3/8"</p>

<p><u>CLEVELAND FAUCET</u> CG20U</p>  <p>HEIGHT..... 1-7/8" WIDTH 15/16" SPLINE D Spline SPLINE WIDTH.... 5/16"</p>	<p><u>KOHLER</u> KO30U</p>  <p>HEIGHT..... 1-7/8" WIDTH 15/16" SPLINE COUNT. Square SPLINE WIDTH. 5/16"</p>	<p><u>PRICE PFISTER</u> PP20U</p>  <p>HEIGHT..... 1-7/8" WIDTH 15/16" SPLINE COUNT. 11 SPLINE WIDTH. 3/8"</p>	<p><u>DELEX</u> 23051</p>  <p>HEIGHT..... 1-15/16" WIDTH 15/16" SPLINED Spline SPLINE WIDTH..5/16"</p>
<p><u>GLACIER BAY</u> GB30U</p>  <p>HEIGHT..... 1-15/16" WIDTH7/8" SPLINE D Spline SPLINE WIDTH..5/16"</p>	<p><u>GLACIER BAY</u> GB40U</p>  <p>HEIGHT.....1-15/16" WIDTH7/8" SPLINED Spline SPLINE WIDTH. 5/16"</p>	<p><u>MARLIN</u> 40100250 & 40100251 Cold Hot</p>  <p>HEIGHT..... 1-15/16" WIDTH 15/16" SPLINED Spline SPLINE WIDTH..5/16"</p>	<p><u>GLACIER BAY</u> GB31U</p>  <p>HEIGHT..... 1-15/16" WIDTH 7/8" SPLINE COUNT...24 SPLINE WIDTH.. 3/8"</p>
<p><u>GLACIER BAY</u> GB35U</p>  <p>HEIGHT..... 1-15/16" WIDTH 7/8" SPLINE D Spline SPLINE WIDTH..1/4"</p>	<p><u>AM/STANDARD</u> AS33U</p>  <p>HEIGHT..... 2" WIDTH 15/16" SPLINE Square SPLINE WIDTH. 3/8"</p>	<p><u>PRICE PFISTER</u> PP32U</p>  <p>HEIGHT..... 2" WIDTH 13/16" SPLINE COUNT.... 12 SPLINE WIDTH....3/8"</p>	<p><u>PRICE PFISTER</u> PP35U</p>  <p>HEIGHT..... 2" WIDTH 1" SPLINE COUNT.... 12 SPLINE WIDTH....3/8"</p>

STEMS BY SIZE

<p><u>SISCO</u> SI30U</p>  <p>HEIGHT..... 2" WIDTH15/16" SPLINE COUNT....24 SPLINE WIDTH...3/8"</p>	<p><u>SPEAKMAN</u> SP30U</p>  <p>HEIGHT..... 2" WIDTH15/16" SPLINE COUNT....20 SPLINE WIDTH...3/8"</p>	<p><u>STERLING FAUCET</u> SF31U</p>  <p>HEIGHT.....2" WIDTH15/16" SPLINED Spline SPLINE WIDTH.5/16"</p>	<p><u>BROADWAY</u> BD3U</p>  <p>HEIGHT.....2-1/16" WIDTH15/16" SPLINE COUNT....20 SPLINE WIDTH..7/16"</p>
<p><u>T&S BRASS</u> 40451043 Cold 40451044 Hot</p>  <p>HEIGHT.....2-1/16" WIDTH15/16" SPLINE COUNT....22 SPLINE WIDTH..5/16"</p>	<p><u>ELIER</u> EL25U</p>  <p>HEIGHT..... 2-1/16" WIDTH 15/16" SPLINE COUNT... 20 SPLINE WIDTH.... 5/16"</p>	<p><u>EZ-FLOW</u> EZ20U</p>  <p>HEIGHT.....2-1/16" WIDTH15/16" SPLINED Spline SPLINE WIDTH. 5/16"</p>	<p><u>UNIVERSAL RUNDLE</u> UR25U</p>  <p>HEIGHT.....2-1/16" WIDTH15/16" SPLINE COUNT...20 SPLINE WIDTH..5/16"</p>
<p><u>SISCO</u> SI35U</p>  <p>HEIGHT..... 2-1/8" WIDTH 7/8" SPLINE COUNT.... 24 SPLINE WIDTH..11/32"</p>	<p><u>BRIZO</u> BZ30U</p>  <p>HEIGHT..... 2-1/8" WIDTH 15/16" SPLINE COUNT.... 20 SPLINE WIDTH... 5/16"</p>	<p><u>BROADWAY</u> BD2U</p>  <p>HEIGHT.....2-1/8" WIDTH15/16" SPLINE COUNT....20 SPLINE WIDTH..5/16"</p>	<p><u>DORNBRACHT</u> DT30U</p>  <p>HEIGHT.....2-1/8" WIDTH15/16" SPLINE COUNT....20 SPLINE WIDTH...5/16"</p>

SYMMONS
SY35U



HEIGHT.....2-1/8"
WIDTH15/16"
SPLINE COUNT.... 20
SPLINE WIDTH...5/16"

ELKAY
EK25U



HEIGHT.....2-1/8"
WIDTH15/16"
SPLINE COUNT...20
SPLINE WIDTH..5/16"

ELKAY
EK30U



HEIGHT.....2-1/8"
WIDTH15/16"
SPLINE COUNT.... 20
SPLINE WIDTH...5/16"

HANS GROHE
HG30U



HEIGHT.....2-1/8"
WIDTH15/16"
SPLINE COUNT....20
SPLINE WIDTH...5/16"

KALLISTA
KT30U

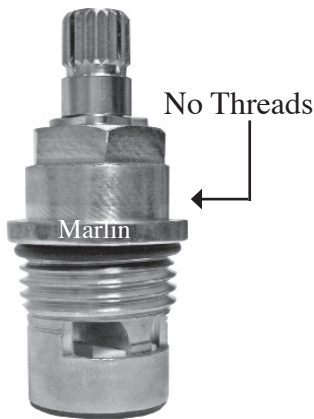

HEIGHT..... 2-1/8"
WIDTH 15/16"
SPLINE COUNT.... 20
SPLINE WIDTH.... 3/8"

KALLISTA
KT35U

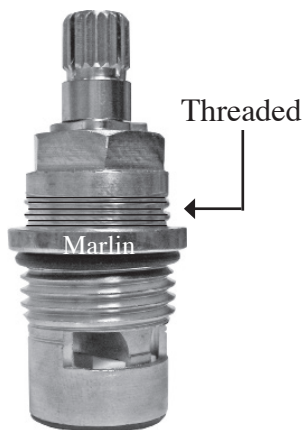







HEIGHT..... 2-1/8"
WIDTH 15/16"
SPLINE COUNT.... 20
SPLINE WIDTH.... 3/8"

KOHLER
KO40U



HEIGHT..... 2-1/8"
WIDTH 1"
SPLINE COUNT.... 20
SPLINE WIDTH.... 5/16"

STEMS BY SIZE

<p>MARLIN 40170213 & 40170214 Hot Cold</p>  <p>HEIGHT..... 2-1/8" WIDTH 15/16" SPLINE COUNT.... 20 SPLINE WIDTH.... 5/16"</p>	<p>PHYLIRICH PY30U</p> <p>BRASS BONNET</p>  <p>HEIGHT..... 2-1/8" WIDTH 15/16" SPLINE COUNT.... 16 SPLINE WIDTH.... 3/8"</p>	<p>SANTEC SN30U</p> <p>CHROME BONNET</p>  <p>HEIGHT..... 2-1/8" WIDTH 15/16" SPLINE COUNT.... 16 SPLINE WIDTH.... 3/8"</p>	
<p>AM/STANDARD AS31U</p>  <p>HEIGHT..... 2-3/16" WIDTH 1" SPLINE COUNT.. 18 SPLINE WIDTH. 5/16"</p>	<p>BROADWAY BD1U</p>  <p>HEIGHT..... 2-3/16" WIDTH 1-1/8" SPLINE COUNT... 20 SPLINE WIDTH. 5/16"</p>	<p>CHICAGO FAUCET CF30U</p>  <p>HEIGHT..... 2-3/16" WIDTH 1" SPLINE .. Square Spline SPLINE WIDTH. 7/16"</p>	<p>JADO JD30U</p>  <p>HEIGHT..... 2-3/16" WIDTH 15/16" SPLINE COUNT. 20 SPLINE WIDTH 5/16"</p>

KINGSTON BRASS
KB30U



HEIGHT..... 2-3/16"
WIDTH 15/16"
SPLINE COUNT.. 15
SPLINE WIDTH. 3/8"

MARLIN
MA30U



HEIGHT..... 2-3/16"
WIDTH 15/16"
SPLINE COUNT.. 32
SPLINE WIDTH. 3/8"

SEPCO
SE30U



HEIGHT..... 2-3/16"
WIDTH 15/16"
SPLINE COUNT. 15
SPLINE WIDTH. 3/8"

ZURN
ZU20U

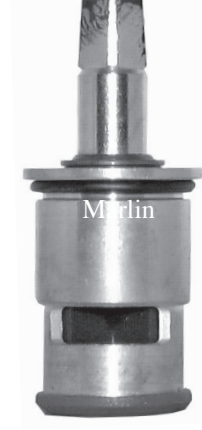

HEIGHT..... 2-3/16"
WIDTH 15/16"
SPLINE ..Square Spline
SPLINE WIDTH. 3/8"

ELKAY
EK32U



HEIGHT..... 2-1/4"
WIDTH 15/16"
SPLINE COUNT... 12
SPLINE WIDTH.... 3/8"

GROHE
GR20U







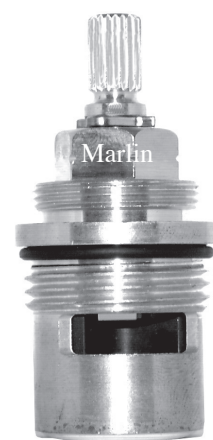

HEIGHT..... 2-1/4"
WIDTH 1"
SPLINE COUNT... 20
SPLINE WIDTH.... 5/16"

KOHLER
KO45U

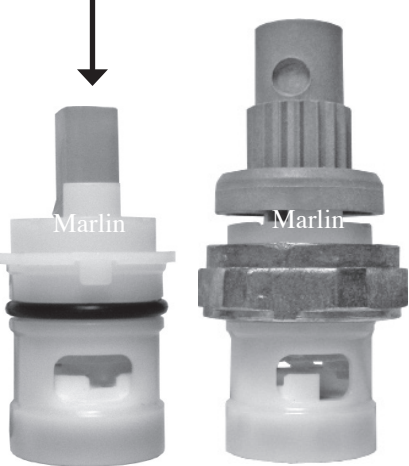

HEIGHT..... 2-1/4"
WIDTH 1-1/16"
SPLINE COUNT... 24
SPLINE WIDTH.... 5/16"

STEMS BY SIZE

<p align="center"><u>STERLING FAUCET</u> SF32U</p>  <p>HEIGHT..... 2-1/4" WIDTH 1" SPLINE COUNT... 16 SPLINE WIDTH... 3/8"</p>	<p align="center"><u>UNIVERSAL RUNDLE</u> UR32U</p>  <p>HEIGHT..... 2-1/4" WIDTH 15/16" SPLINE COUNT... 12 SPLINE WIDTH... 3/8"</p>	<p align="center"><u>AM/STANDARD</u> AS41U</p> <p align="center">View without adapter</p>  <p>HEIGHT..... 2-5/16" WIDTH 1-1/16" SPLINE D Spline SPLINE WIDTH... 5/16" ADAPTER 01898021</p>	
<p align="center"><u>HANS GROHE</u> HB30U</p>  <p>HEIGHT.....2-5/16" WIDTH15/16" SPLINE COUNT...16 SPLINE WIDTH...3/8"</p>	<p align="center"><u>DELTA</u> DE35U</p>  <p>HEIGHT..... 2-3/8" WIDTH 7/8" SPLINE COUNT..16 SPLINE WIDTH..3/8"</p>	<p align="center"><u>ALTMANS</u> AT30U</p>  <p>HEIGHT..... 2-3/8" WIDTH 7/8" SPLINE COUNT..16 SPLINE WIDTH..3/8"</p>	<p align="center"><u>DORNBRACHT</u> DT35U</p>  <p>HEIGHT.....2-3/8" WIDTH1-1/8" SPLINE COUNT...20 SPLINE WIDTH..5/16"</p>

DORNBRACHT
DT40U

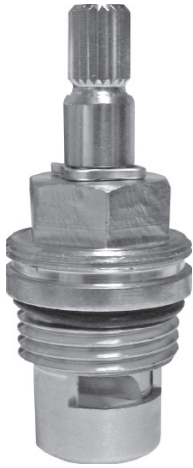

HEIGHT.....2-3/8"
WIDTH15/16"
SPLINE COUNT...20
SPLINE WIDTH...5/16"

SEPCO
SE35U



HEIGHT.....2-3/8"
WIDTH15/16"
SPLINE COUNT...13
SPLINE WIDTH...3/8"

SPEAKMAN
SP32U



HEIGHT.....2-3/8"
WIDTH15/16"
SPLINE COUNT..20
SPLINE WIDTH...3/8"

SUPERGRIF
SG30U



HEIGHT.....2-1/2"
WIDTH15/16"
SPLINE COUNT.. 20
SPLINE WIDTH..5/16"

SUPERGRIF
SG35U



HEIGHT.....2-1/2"
WIDTH15/16"
SPLINE COUNT.. 20
SPLINE WIDTH..5/16"

KOHLER
KO46U



HEIGHT.....2-1/2"
WIDTH 7/8"
SPLINE COUNT.. 19
SPLINE WIDTH..7/16"

SEPCO
SE40U











HEIGHT.....2-1/2"
WIDTH1-1/8"
SPLINE COUNT...15
SPLINE WIDTH...3/8"

PHYLIRICH
PY35U



HEIGHT.....2-9/16"
WIDTH15/16"
SPLINE COUNT....16
SPLINE WIDTH...3/8"

STEMS BY SIZE

<p><u>SUPERGRIF</u> SG40U</p>  <p>HEIGHT.....2-9/16" WIDTH1-1/8" SPLINE COUNT.. 20 SPLINE WIDTH.5/16"</p>	<p><u>KOHLER</u> KO44U</p>  <p>HEIGHT..... 2-9/16" WIDTH 13/16" SPLINE COUNT.. 19 SPLINE WIDTH. 7/16"</p>	<p><u>GLACIER BAY</u> GB45U</p>  <p>HEIGHT..... 2-5/8" WIDTH 1-1/8" SPLINE COUNT... 38 SPLINE WIDTH... 3/8"</p>	<p><u>SANTEC</u> SN35U</p>  <p>HEIGHT.....2-5/8" WIDTH15/16" SPLINE COUNT...16 SPLINE WIDTH.5/16"</p>
<p><u>SEPCO</u> SE45U</p>  <p>HEIGHT.....2-5/8" WIDTH15/16" SPLINE COUNT..15 SPLINE WIDTH..3/8"</p>	<p><u>SIGMA / ALTMANS</u> SM30U</p>  <p>HEIGHT.....2-5/8" WIDTH15/16" SPLINE COUNT.... 16 SPLINE WIDTH.... 3/8"</p>	<p><u>KOHLER</u> KO41U</p>  <p>HEIGHT.....2-11/16" WIDTH15/16" SPLINE COUNT....20 SPLINE WIDTH...5/16"</p>	<p><u>PHYLIRICH</u> PY40U</p>  <p>HEIGHT.....2-11/16" WIDTH15/16" SPLINE COUNT.... 16 SPLINE WIDTH....3/8"</p>

ALTMANS
AT40U



HEIGHT..... 2-3/4"
WIDTH 15/16"
SPLINE COUNT... 16
SPLINE WIDTH.... 5/16"

AM/STANDARD
AS54U

Dualux

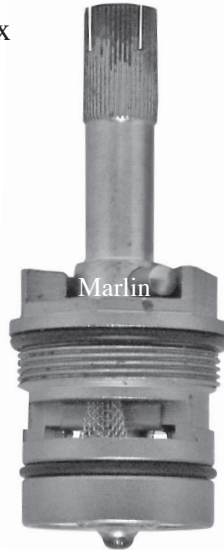

HEIGHT..... 2-3/4"
WIDTH 1-1/8"
SPLINE Split
SPLINE WIDTH.... 3/8"

ELJER
EL30U

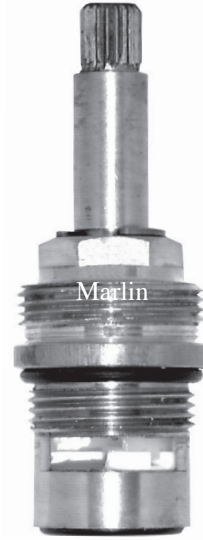

HEIGHT..... 2-3/4"
WIDTH 1"
SPLINE COUNT... 20
SPLINE WIDTH.... 5/16"

ALTMANS
AT35U



HEIGHT..... 2-13/16"
WIDTH 1-1/8"
SPLINE COUNT... 16
SPLINE WIDTH.... 3/8"

CHICAGO FAUCET
CF40U



HEIGHT..... 2-7/8"
WIDTH 1"
SPLINE Square Spline
SPLINE WIDTH.... 7/16"

WOLVERINE BRASS
WB30U



HEIGHT..... 2-7/8"
WIDTH 1"
SPLINE COUNT... 16
SPLINE WIDTH.... 3/8"

STEMS BY SIZE

ZURN
ZU30U



HEIGHT..... 2-7/8"
 WIDTH 15/16"
 SPLINE Square Spline
 SPLINE WIDTH.... 3/8"

DORNBRACHT
DT45U



HEIGHT..... 2-15/16"
 WIDTH 1-1/8"
 SPLINE COUNT... 20
 SPLINE WIDTH.... 5/16"

PHYLIRICH
PY45U



HEIGHT..... 2-15/16"
 WIDTH 15/16"
 SPLINE COUNT... 16
 SPLINE WIDTH.... 3/8"

PHYLIRICH
PY46U



HEIGHT..... 3"
 WIDTH 7/8"
 SPLINE COUNT. 16
 SPLINE WIDTH. 3/8"

ZURN
39999626



HEIGHT..... 3"
 WIDTH 15/16"
 SPLINE Square Spline
 SPLINE WIDTH. 5/16"

T&S BRASS
TS30U



HEIGHT..... 3-1/16"
 WIDTH 15/16"
 SPLINE COUNT. 20
 SPLINE WIDTH. 7/16"

PHYLIRICH
PY55U



HEIGHT..... 3-1/8"
 WIDTH 15/16"
 SPLINE COUNT... 16
 SPLINE WIDTH. 3/8"

SPEAKMAN
SP36U



HEIGHT..... 3-1/4"
 WIDTH 15/16"
 SPLINE COUNT... 20
 SPLINE WIDTH... 3/8"

UNION BRASS
UB44U



HEIGHT..... 3-5/16"
 WIDTH 1"
 SPLINE COUNT... 16
 SPLINE WIDTH... 3/8"

BROADWAY
BD4U



HEIGHT..... 3-3/8"
 WIDTH 1-1/8"
 SPLINE COUNT... 20
 SPLINE WIDTH... 7/16"

AM/STANDARD
AS67DU



HEIGHT..... 3-3/8"
 WIDTH 15/16"
 SPLINE D Spline
 SPLINE WIDTH... 1/4"

PHYLIRICH
PY56U



HEIGHT.....3-3/8"
 WIDTH7/8"
 SPLINE COUNT...16
 SPLINE WIDTH...3/8"

DORNBRACHT
DT50U



HEIGHT.....3-7/16"
 WIDTH15/16"
 SPLINE COUNT... 20
 SPLINE WIDTH...5/16"

BROADWAY
BD5U



HEIGHT..... 3-1/2"
 WIDTH 15/16"
 SPLINE COUNT...20
 SPLINE WIDTH...5/16"

STEMS BY SIZE

HARDEN BRASS
HD1U



HEIGHT..... 3-1/2"
WIDTH 15/16"
SPLINE COUNT... 16
SPLINE WIDTH... 3/8"

PHYLIRICH
PY60U



HEIGHT..... 3-1/2"
WIDTH 15/16"
SPLINE COUNT... 16
SPLINE WIDTH... 3/8"

ELJER
EL40U



HEIGHT..... 3-5/8"
WIDTH 15/16"
SPLINE COUNT... 20
SPLINE WIDTH... 5/16"

SPEAKMAN
SP72U



HEIGHT..... 3-5/8"
 WIDTH 15/16"
 SPLINE COUNT.... 20
 SPLINE WIDTH.... 3/8"

STERLING FAUCET
SF33U



HEIGHT..... 4"
 WIDTH 1-1/16"
 SPLINE Square Spline
 SPLINE WIDTH.... 5/16"

AM/STANDARD
AS55U



HEIGHT..... 4-1/8"
 WIDTH 1"
 SPLINE COUNT.... 18
 SPLINE WIDTH.... 3/8"

STEMS BY SIZE

KOHLER
KO75U



HEIGHT..... 4-1/4"
WIDTH 15/16"
SPLINE COUNT.... 16
SPLINE WIDTH.... 3/8"

WOLVERINE BRASS
WB60U



HEIGHT..... 4-1/4"
WIDTH 1"
SPLINE COUNT.... 15
SPLINE WIDTH.... 3/8"

UNIVERSAL RUNDLE
UR75U



HEIGHT..... 4-3/8"
WIDTH 15/16"
SPLINE COUNT.... 20
SPLINE WIDTH.... 5/16"

PRICE PEISTER
PP45U



HEIGHT..... 4-1/2"
WIDTH 1-1/8"
SPLINE COUNT.... 12
SPLINE WIDTH.... 3/8"

STERLING FAUCET
SF58U



HEIGHT..... 4-1/2"
WIDTH 1"
SPLINE Square Spline
SPLINE WIDTH.... 5/16"

STEMS BY SIZE

PRICE PEISTER
PP75U



HEIGHT..... 4-5/8"
WIDTH 1-3/16"
SPLINE COUNT.... 12
SPLINE WIDTH.... 3/8"

SAYCO
SA70U



HEIGHT..... 4-3/4"
WIDTH 15/16"
SPLINE COUNT.... 16
SPLINE WIDTH.... 3/8"

PHYLRICH
PY70U



HEIGHT..... 4-7/8"
WIDTH 15/16"
SPLINE COUNT.... 16
SPLINE WIDTH.... 3/8"

CENTRAL BRASS
CB71U



HEIGHT..... 5-1/4"
WIDTH 7/8"
SPLINE COUNT.... 16
SPLINE WIDTH.... 3/8"

GERBER
GE75U



HEIGHT..... 5-1/2"
WIDTH 1-1/8"
SPLINE COUNT.... 16
SPLINE WIDTH.... 3/8"

SECTION 3

THERMOSTATIC CARTRIDGES



GROHE

GR80U

HEIGHT 4-3/4"

(Not Actual Size)



GROHE

GR81U

HEIGHT 3-7/8"

(Not Actual Size)



GROHE

GR82U

HEIGHT 3-1/4"

(Not Actual Size)



GROHE

GR83U

HEIGHT 5-7/16"



(Not Actual Size)



(Thermostatic Mixing Valves)

GROHE

GR84U

HEIGHT 4-9/16"



GROHE*
1/2"



(Not Actual Size)

GROHE

GR85U

HEIGHT 4-3/8"



(Not Actual Size)

GROHE

GR86U

HEIGHT 3-1/4"



GROHE*
1/2"



(Not Actual Size)

GROHE

GR87U

HEIGHT 5"



GROHE*
1/2"



(Not Actual Size)

GROHE

GR88U

HEIGHT 4-1/8"

(Not Actual Size)



GROHE

GR89U

HEIGHT 4"

(Not Actual Size)



HANS GROHE

HG80U

HEIGHT 5-1/4"

Spline
Count 

(Not Actual Size)



HANS GROHE

HG81U

HEIGHT 4-1/2"

Spline
Count 

(Not Actual Size)



HANS GROHE

HG82U

HEIGHT 3-3/4"

Spline
Count **20**

(Not Actual Size)



HANS GROHE

HG83U

HEIGHT 3-3/4"

Spline
Count **20**

(Not Actual Size)



KOHLER

KO80U

HEIGHT 4"

Spline
Count **20**

(Not Actual Size)



MOEN

MO80U

HEIGHT 4"

Spline
Count **20**

(Not Actual Size)



Other catalogs, to help you find what you are looking for!



 Quality Line-Plumbing Specialties Orlando, Florida

*Servicing the Southeast
"Since 1965"*

 E-mail: customerservice@tmsmarlin.com

 Toll Free: 1-800-327-3022 Fax Free: 1-800-327-5689

2022

Sensor Activated





**Flush Valves
Faucets
Hand Dryers
Side Mounts
Soap Dispensers**

Servicing the Southeast Since 1965

 ORLANDO, FLORIDA

2023

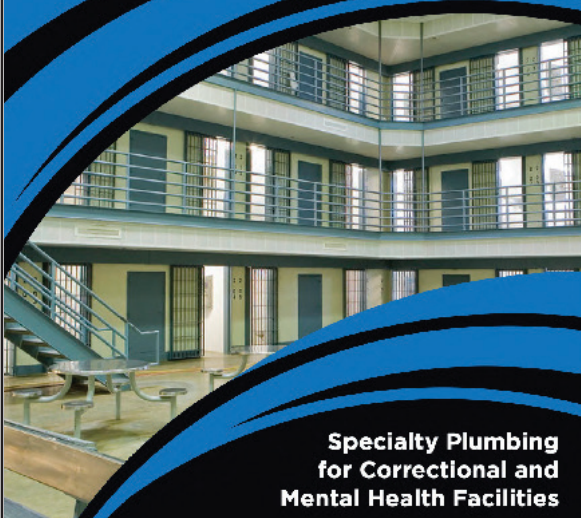
 QUALITY LINE-PLUMBING SPECIALTIES



**Specialty Plumbing
for Correctional and
Mental Health Facilities**



 Quality Line-Plumbing Specialties Orlando, Florida

*Servicing the Southeast
"Since 1965"*

 Toll Free: 1-800-327-3022

 Fax Free: 1-800-327-5689

Vitreous China

 Sloan's Vitreous China fixtures incorporate cutting-edge water saving designs that will cut your water usage down to it's absolute minimum.



**Reliable Foundations for
Great Savings!!**





 Quality Line-Plumbing Specialties

Manufacturing Company, Inc.

**REPAIR PARTS
CATALOG 2021**



**Over 25,000
Items in stock**

*Servicing the Southeast
"Since 1965"*

TOLL FREE 1-800-327-3022 FAX FREE 1-800-327-5689